

() /

2022 08

()

FENGEN

未盖印章 未授权 擅

()

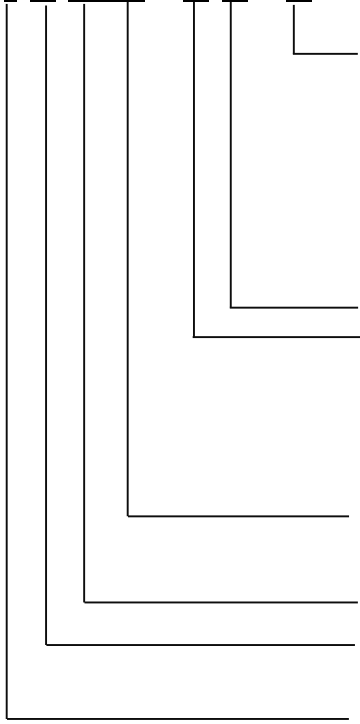

未 盖印章
未 授权 擅

()

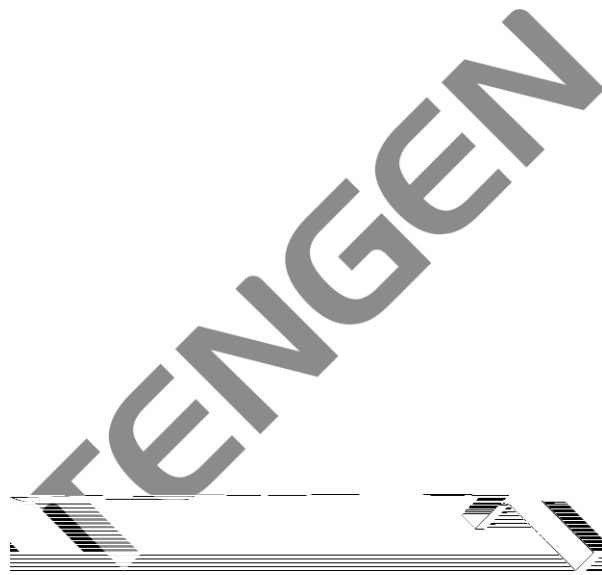

()

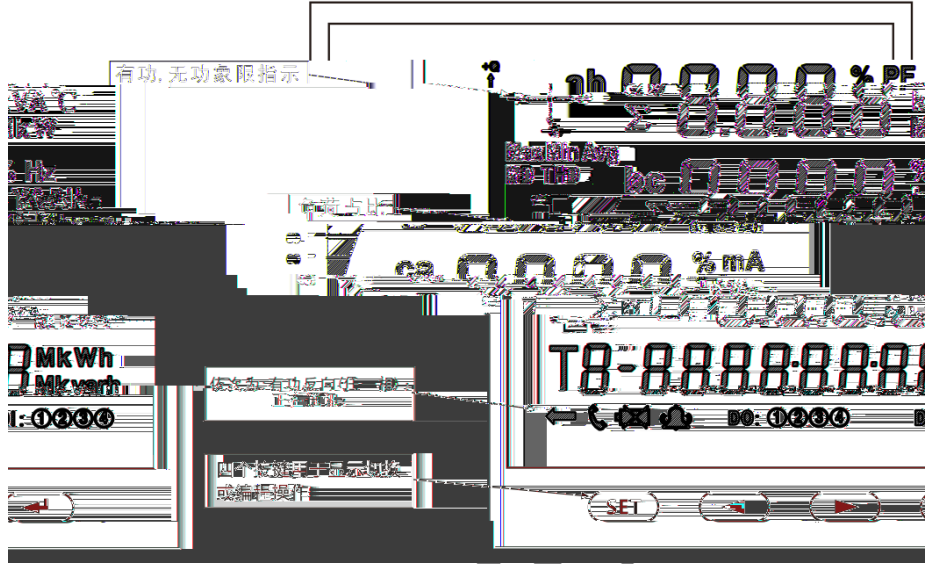

=		=
=		=

擅 授 未 盖 印 章

()

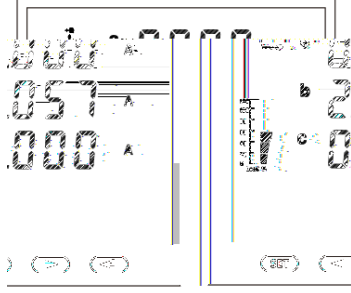
=		=
---	---	---

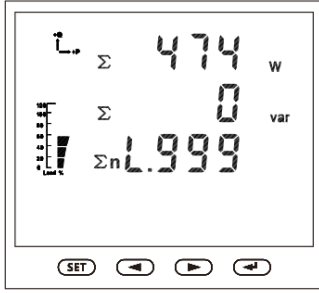
=		=
---	---	---

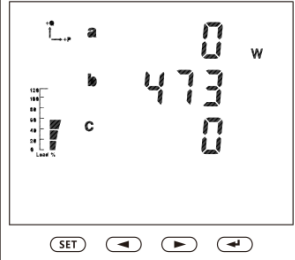
=		=
---	--	---

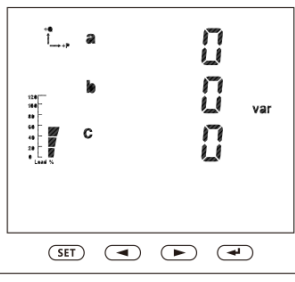
=		=
---	---	---

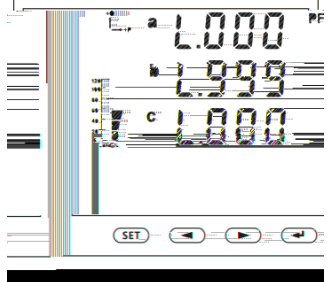
=		=
---	---	---

未盖印章 未授权 擅

()

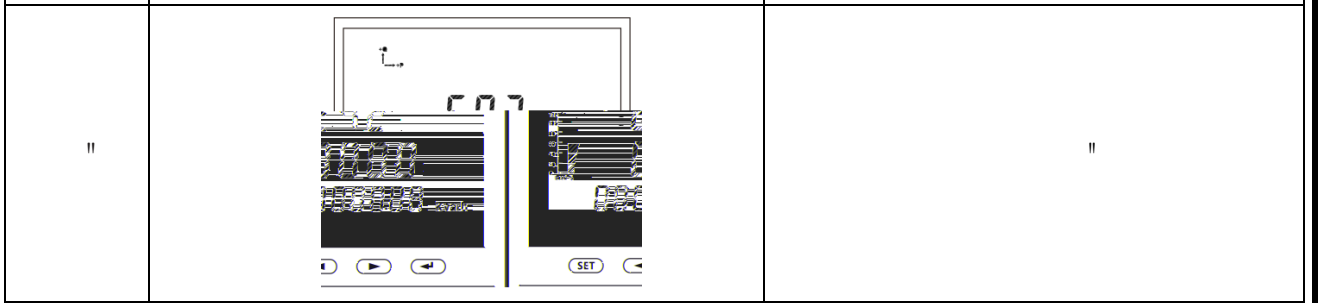
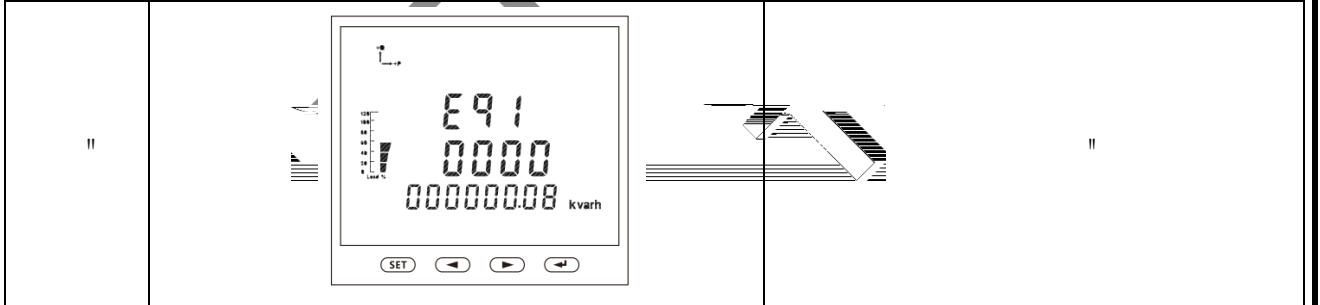
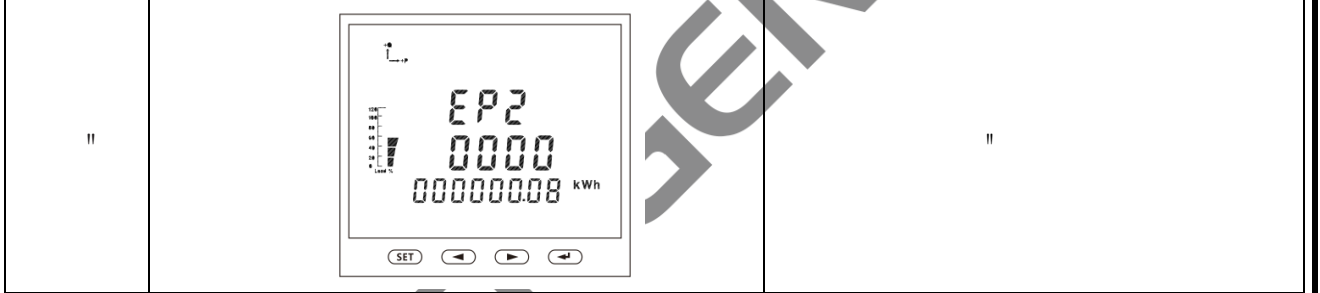
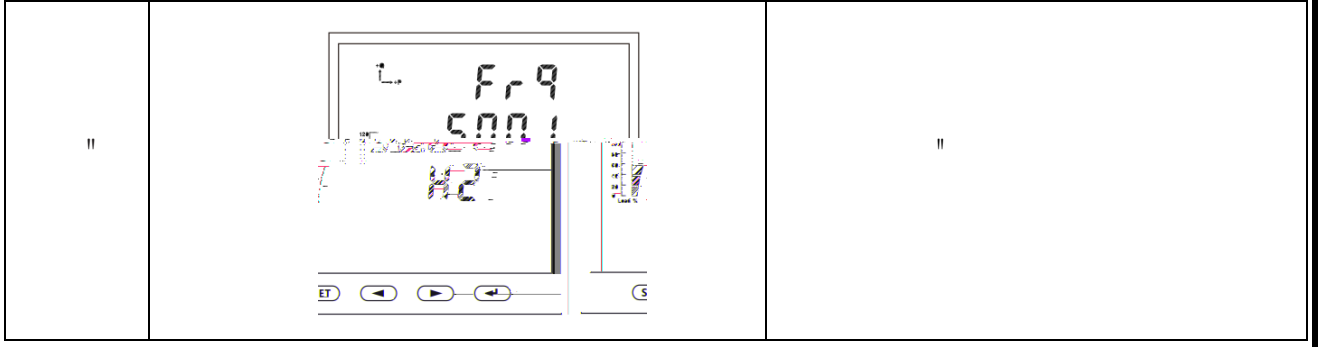

未 盖印章 未 授权 擅

()

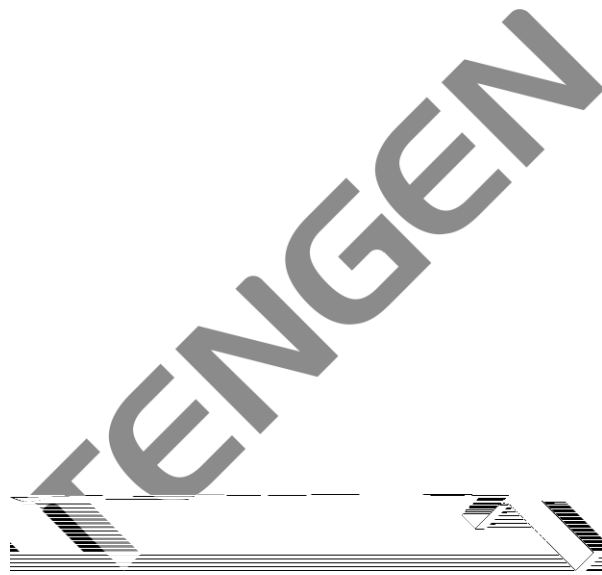

()

■	Base		
	bHud		
	Prot		

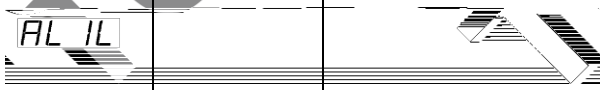
ALn1	AL IP		
	AL IH		
	AL IL		
	dF		
	dt		

未授权擅盖印章

()

- SET 移位
- ◀ 加
- ▶ 减
- ◀▶ 确认返回

SET 电压倍率范围
1~2000

SE 电压零点屏
蔽: 0~60%

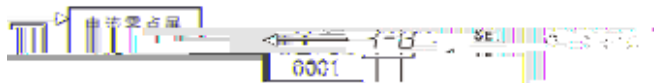

仪表上电

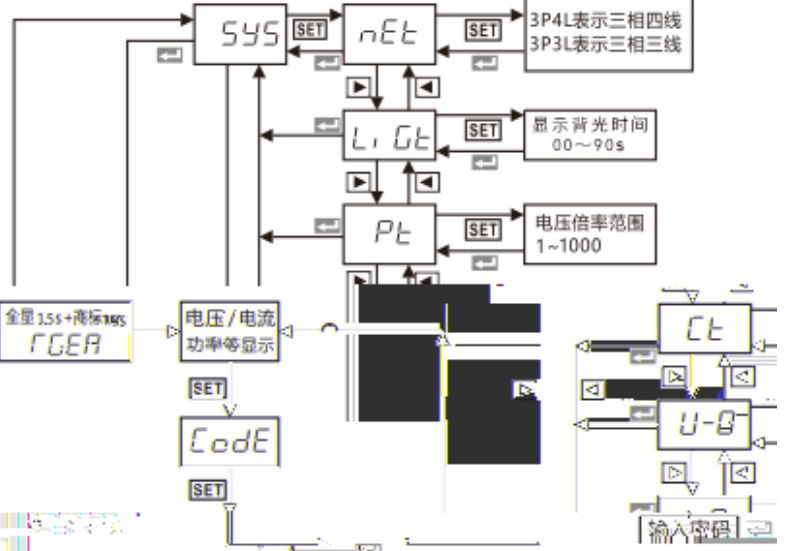

擅 授 权 未 盖 印 章

()

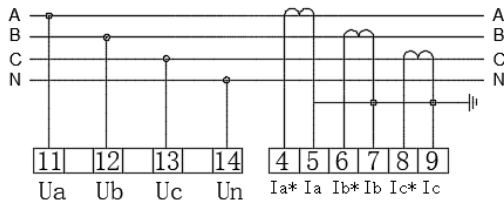

三相四线电流互感器接入

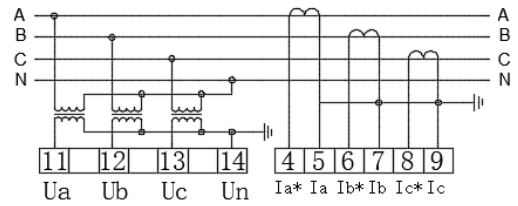

三相四线电压电流互感器接入

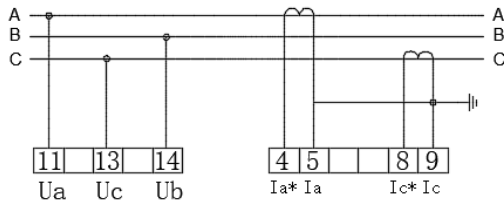

三相三线电流互感器直接接入

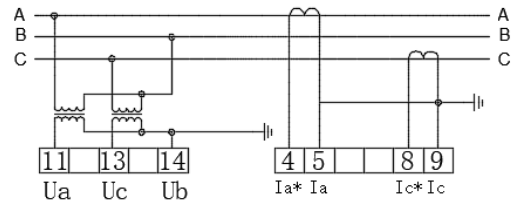

三相三线电压电流互感器接入

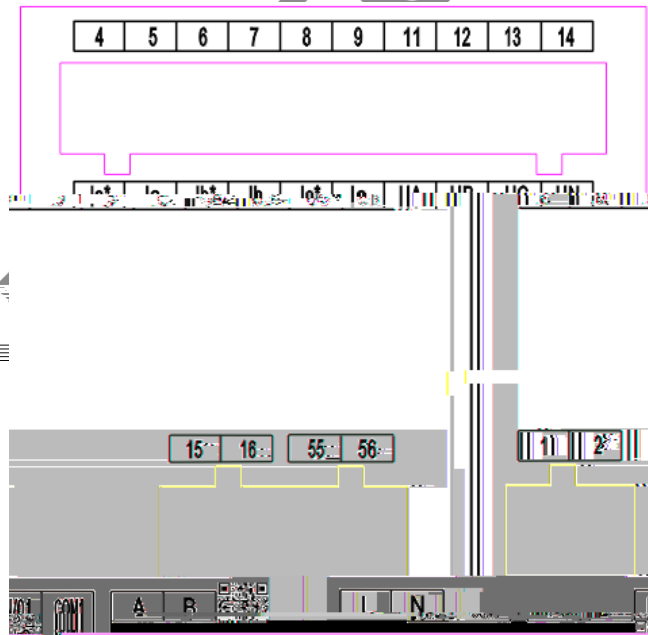

擅
授
未
盖
未

()

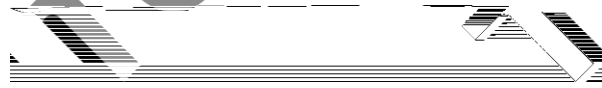

未 盖印章
未 授权 擅

()

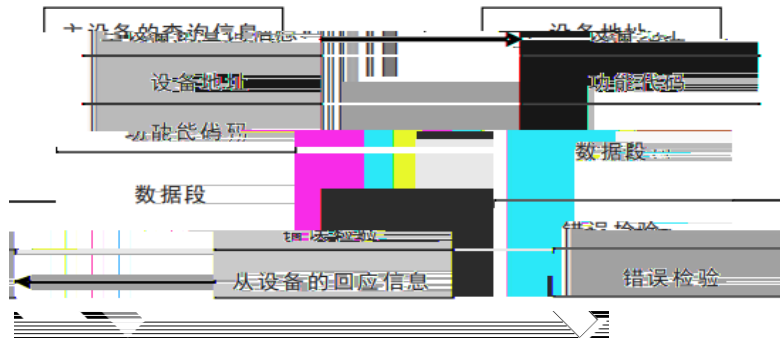
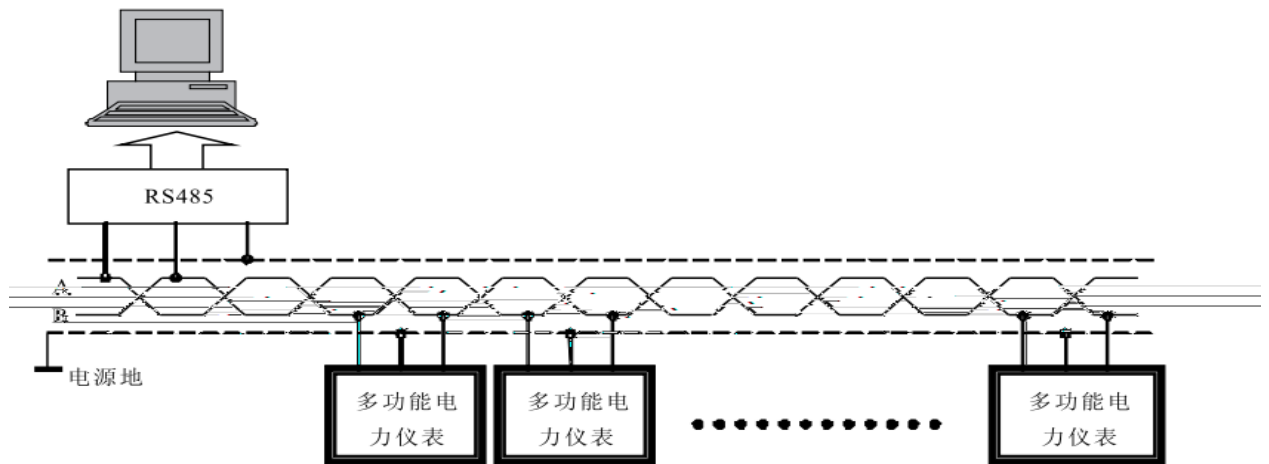

擅 授 未 盖 未 印 章

()

FENGEN

未盖印章 未授权 擅

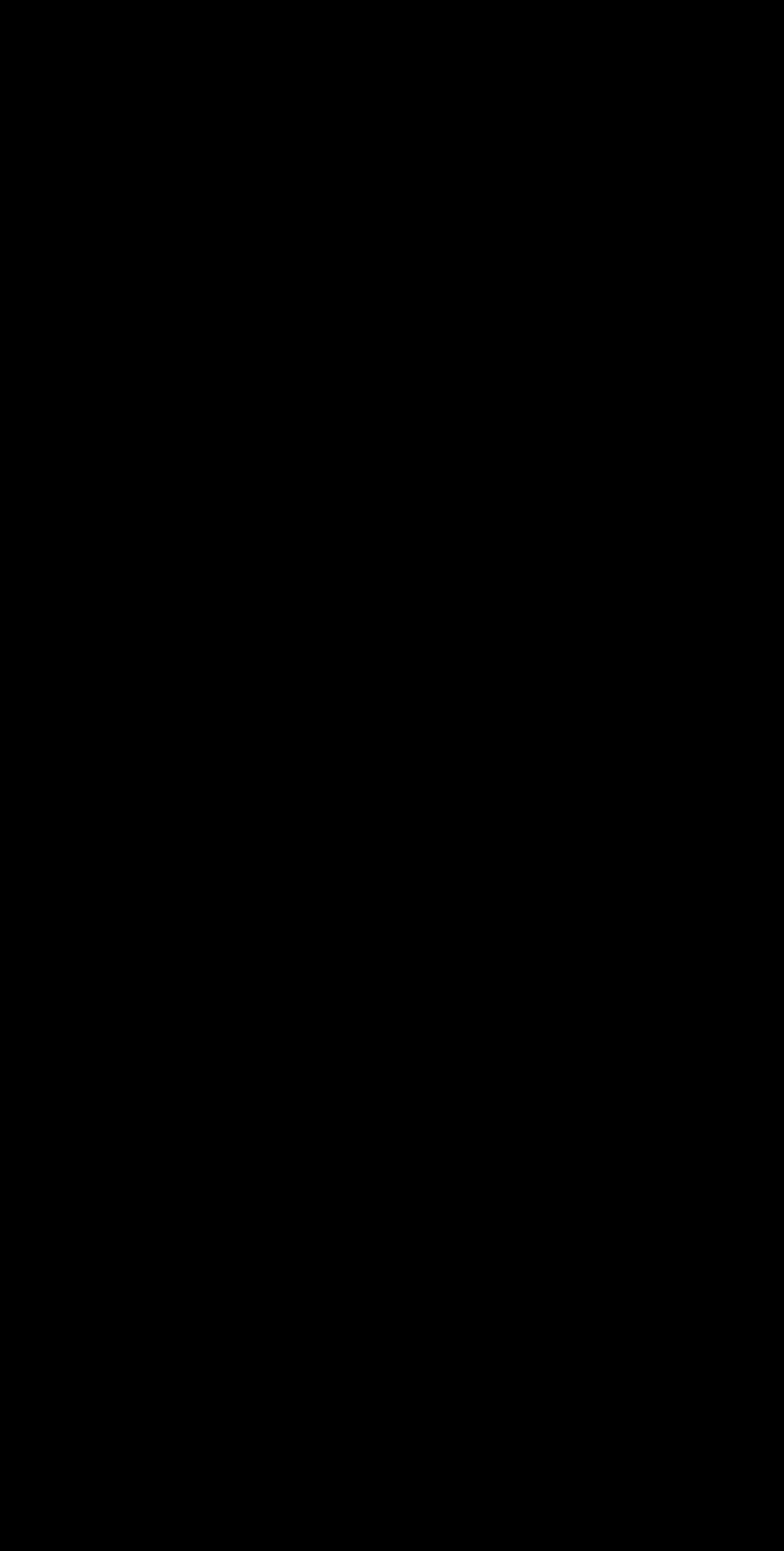

()

--	--	--	--	--

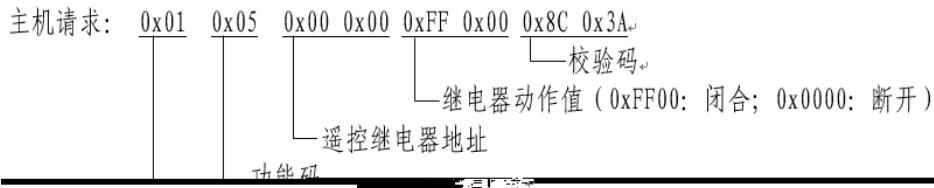

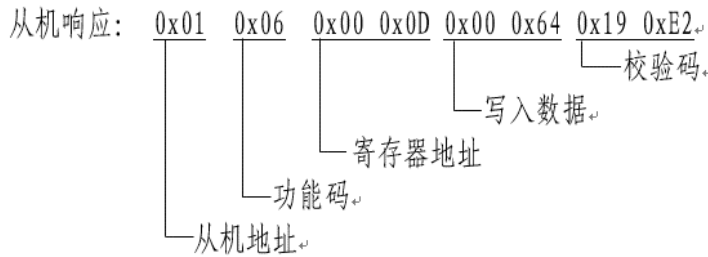
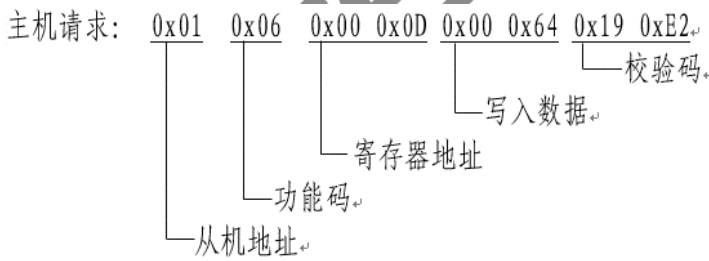

擅 授 权 未 盖 印 章 未

()

FENGEN

未盖印章 未授权 擅

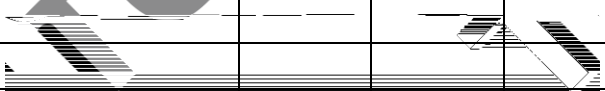

未盖印章 未授权 擅

()

FENGEN

擅

未授权

未盖印章

()

FENGEN

擅

未授权

未盖印章

()

↓

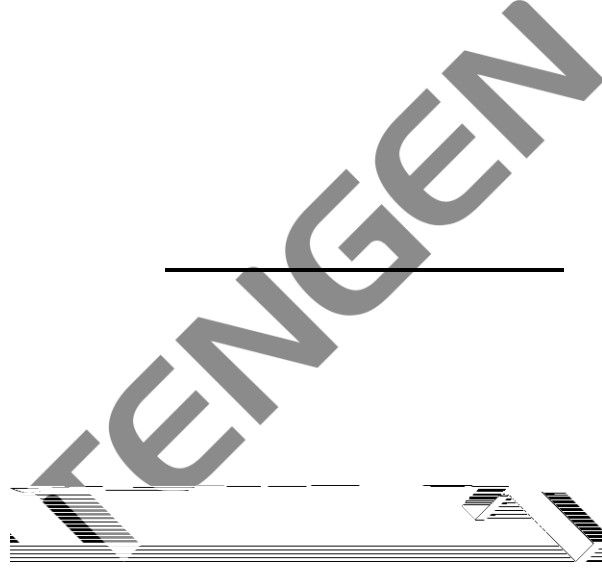

未盖印章 未授权 擅

()

FENGEN

未盖印章 未授权 擅

()

未盖印章 未授权 擅

FENGEN

()

FENGEN

未盖印章 未授权 擅
